

With the Tanto Race you got one of the most comfortable and most functional harnesses, which is available on the market at present. We thank you for the confidence, for buying the Tanto Race harness.

Please read this operating instructions carefully and consider, that AVA Sport Ltd. can not be made liable for accidents and damage, which result from disregarding of the operating instructions.

Technical description:

- ✍ Aerodynamic cover of the pilot
- ✍ EN & LTF certified
- ✍ Max. pilot's weight: 120 kg
- ✍ Running through shoulder belts for perfect comfort
- ✍ Weight of the harness: 6,4 kg (depending Version) Size L
- ✍ Seatposition adjustable in flight
- ✍ two rescue container (left and right)
- ✍ Removable back part
- ✍ water-bag storage

Owner's manual

Tanto RACE

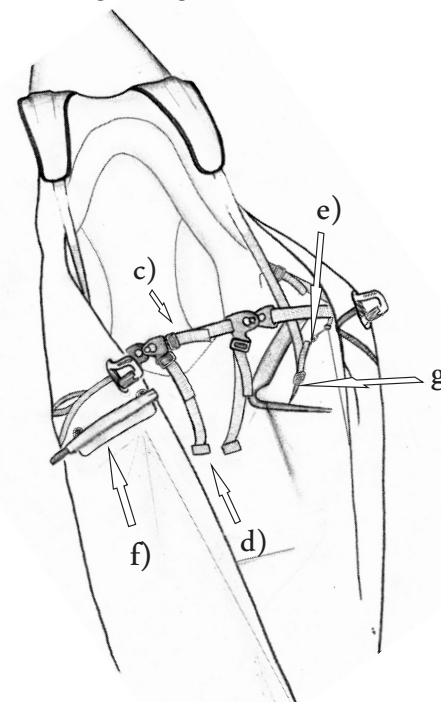

- a) Main suspension
- b) side belt adjustment
- c) Lateral chest-belt adjustment
- d) Leg belts with combi-safety-system
- e) 1. Fixation (cover of the pilot)
- f) 2. Zip fastener (cover of the pilot)
- g) Adjustment shoulder straps

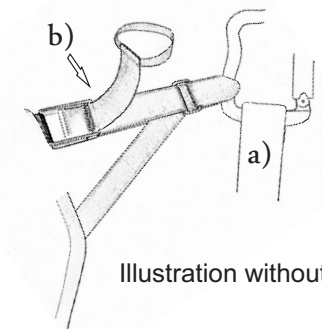

Illustration without cover!

1. Adjustment possibilities:

By the versatile adjusting possibilities of the Tanto Race we recommend in any case that all adjustments are done in a simulator before the first flight to guarantee an optimal seat comfort.

Adjusting the chest belt:

The chest belt gets closed in combination with the leg belts. The length can be adjusted between the buckles. An adjusting during flight is not possible.

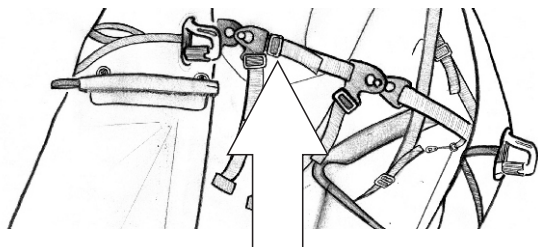

Adjusting the shoulder belts:

Please note that with correct adjusting the shoulder belts are felt with light pressure on the shoulders. With the shoulder belts you adjust the harness on the pilot's height, but also you adjust the seat position between sitting and lying.

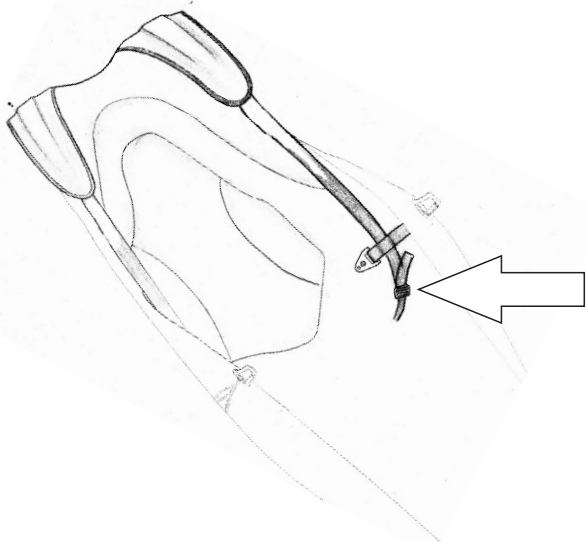

setting maximum length (lying)

page 2

Adjusting the lateral chest belts:

Adjusting the lateral chest belts takes place as third step and offers on the one hand again the variation of the seat position between sitting and lying, on the other hand you adjust with the lateral chest belts the most comfortable seat position. During adjusting it should be paid attention to the fact that the body load is distributed evenly on shoulder belt and lateral chest belt. Please take care that the lateral chest belt is attached correctly to the main suspension's carabiners as shown at pic. below.

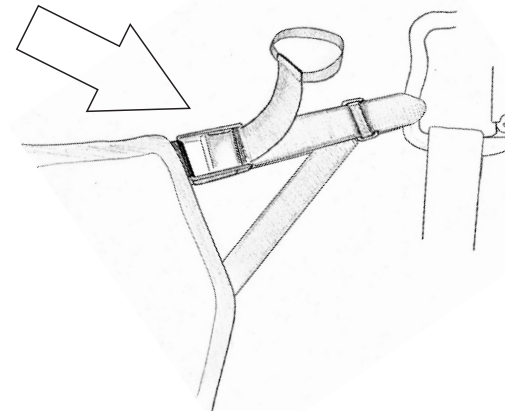

Adjusting the leg-cover:

The neopren-part of the leg-cover gets closed crosswise with the plastic buckles near the carabiners. The inner leg-bag made of Nylon-fabric can be adjusted individually on the leg length of the pilot. The adjusting-fastener therefore are at the innerside of the leg-cover.

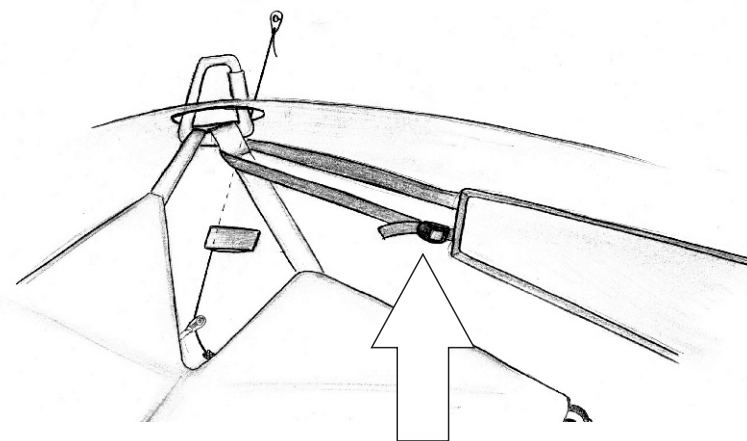

page 3

Adjusting the leg belts:

When you put the harness on, please take care that the buckles are closed correctly and audibly. The leg belts should be fastened tight but should leave still enough space, for the starting and landing phase, where the legs should have still some space to move. The length can be adjusted at the leg belts underneath the buckles. An adjusting during flight is not possible.

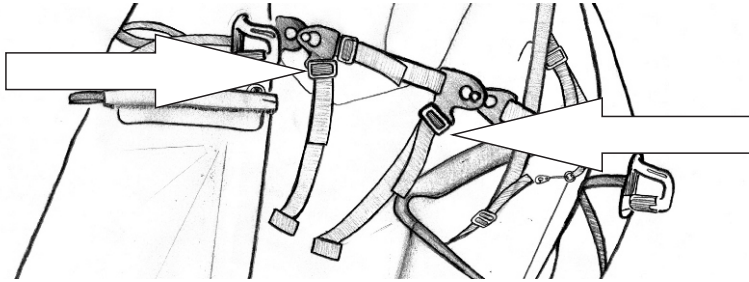

Setting the agility

The Tanto Race has a setting which the harness can be Agile or stable. The adjustment is made by the ropes which are located between the upper chest straps and the main suspension.

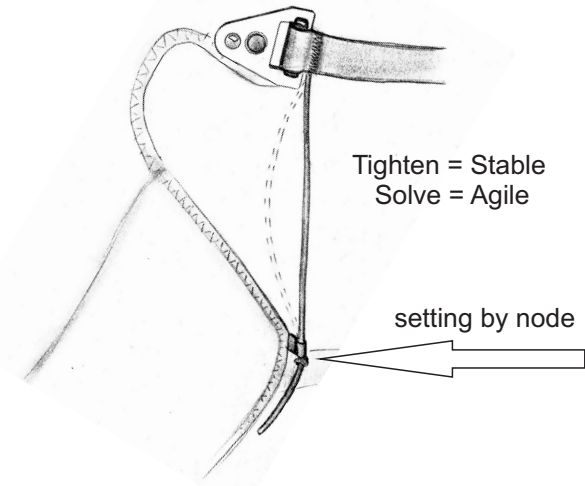

Speed-bar:

The speed-bar is generally built in and runs from the risers as follows:

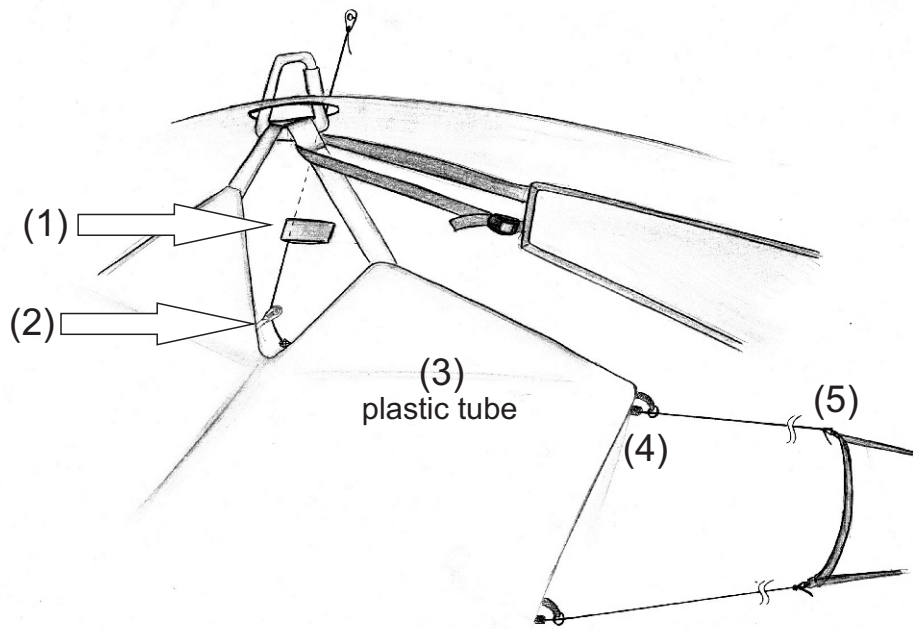

Attaching the Carabiner

Attach the carabiner as follows: Main suspension
Hook and lateral straps in carabiner (1). Leg bag with a Velcro as illustration (2)

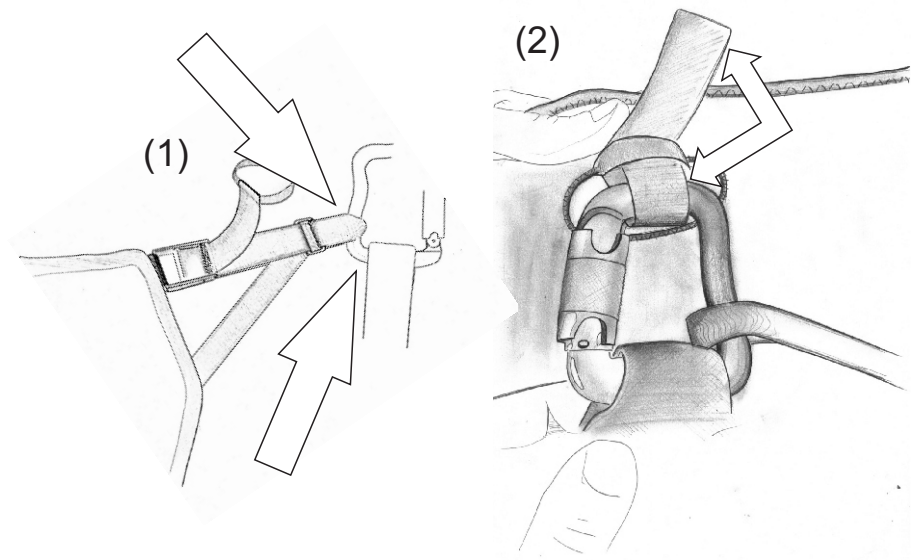

Rescue concept Tanto Race:

The Tanto Race was built in 2012 for the newer generation of Reserve parachuts. It has the **possibility to pack in two rescues**, in case of emergency it can be released with the left or right hand, or can be released when the first Rescue failed. To avoid unnecessary sliding (of the new rescues on the marked smaller, lighter) in the harness Container, the Container of the Tanto Race is adjusted to does new Rescues. Ask your dealer which Reserve parachut is best to use.

2. Build-in of the rescue-system

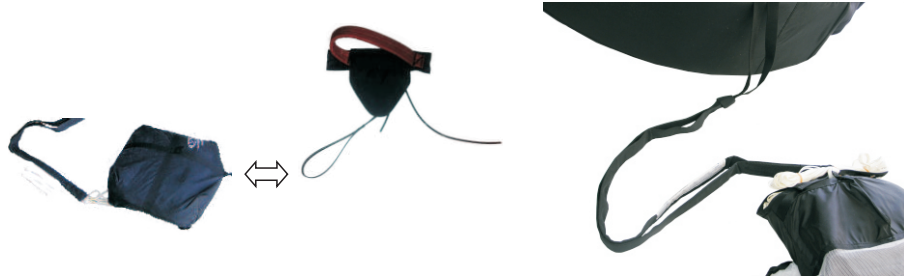

Fix the Harness Handle on the Rescue Container

Connection between Rescue and Harness.

Note: the tanto Race has two release- Handles , there is a left and a right release-handle

Put in the rescue container. The connected handle is showing to the seatboard and the container opening of the harness.

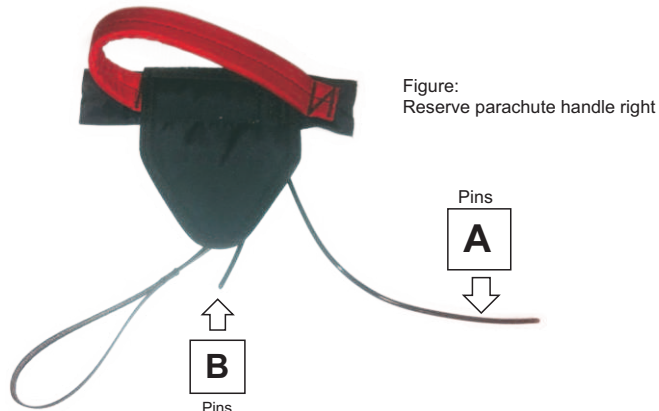



Pins

page 6

Close the container with two packing cords.

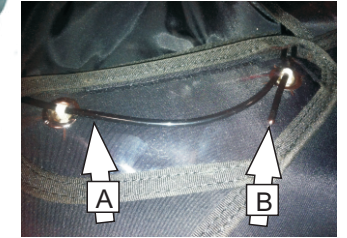
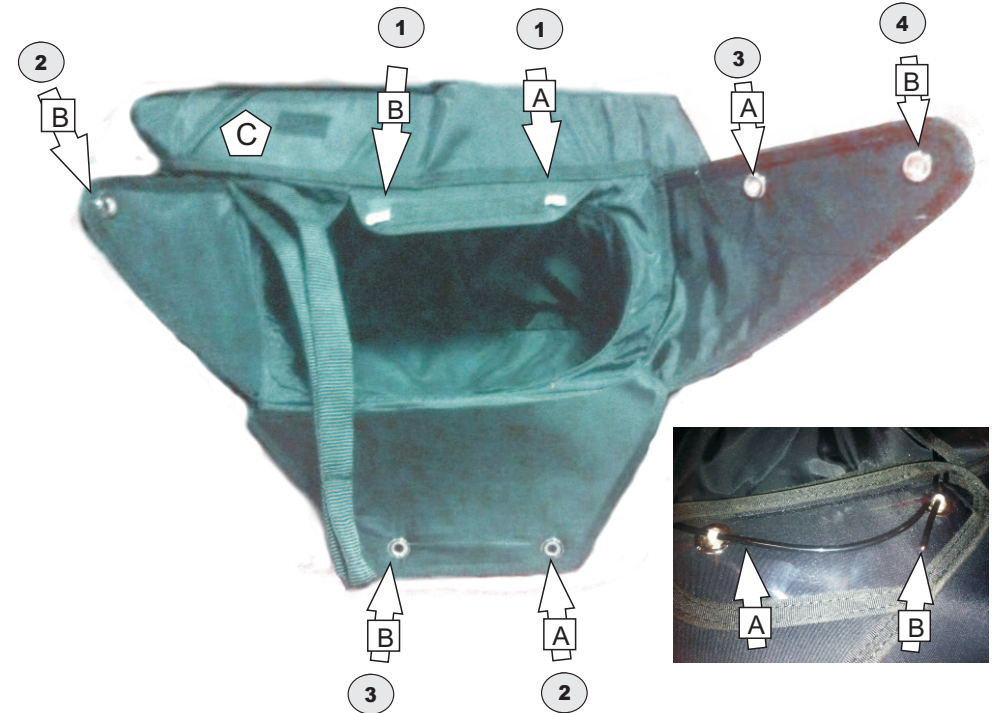
Order: A1 A2 A3 B1 B2 B3 B4



After closing the container, by putting in the pins, remove the packing cords and put the release-handle in the therefore assigned pockets 

Attention:

After every installation of a rescue-system in a harness there must be a test if the opening force is between 2 and 5 daN. If harness and rescue parachute are combined the first time a compatibility check have to be done by a authorized person!

page 7

Back-protector:

Only the original back-protector which is delivered with the Tanto Race is allowed to use. To build-in and -out the protector is reachable by the zipper of the back pocket of the harness.

For rebuilding-in the protector you have to take care that the protector is put in the therefore assigned pockets in the protector-bag of the harness. The Velcros of protector and protector-bag have to be fixed with each other to avoid an unintentional movement of the protector.

Function:

On a impact of the pilot the protector gets compressed and absorbs so the energy of the impact. This minimizes the probability of serious spine injuries but does not except it. Because the protector is very flexible you don't have to make any adjustments at the protector itself.

On waterlandings you should get rid of the harness as soon as possible, because the buoyancy of the protector may turn the pilot upside down and pushes him under the water surface.
There are no special restrictions concerning towing&winching.

Build-in:

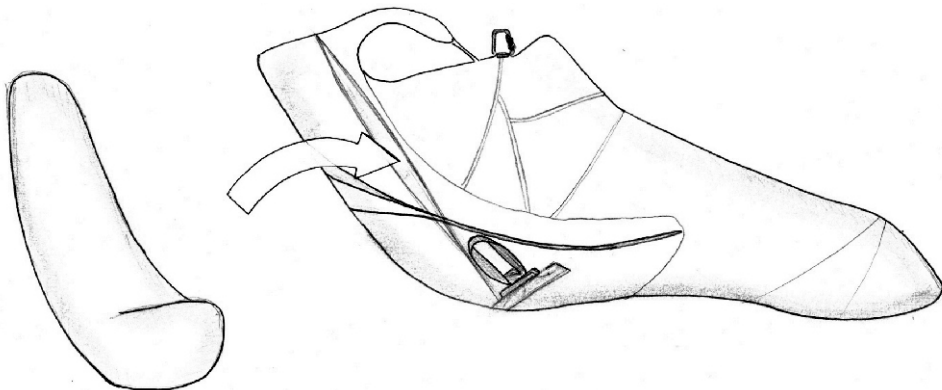

For building-in the protector you have to take care that the protector is put in the therefore assigned pockets in the protector-bag of the harness. The Velcros of protector and protector-bag have to be fixed with each other to avoid an unintentional movement of the protector.

Maintenance

The protector is maintenance free and can still be used after an impact, if you can not see any damages! But anyway avoid high temperatures (for example in the car) and contact with corrosive or etching substances. If, what normally is not necessary, the protector needs to be cleaned, just use water and soft soap. The provisional duration of life are 5 years. Please give us a call after this 5 years, because then we have checked even older protectors' function and performance, and can decide over a longer duration of life. (What most probably will not be a problem).

Removable back part:

Description:

The Tanto Race features a removable back part, which can be removed. The back part can be removed by pulling on the Velcro.

Water-ballast:

A water-ballast-bag (available as an accessorie) can be placed into the harness under the seatboard's frontal edge (see overview illustration at point a)). The function of the rescue-parachute and of the protector-system have to be checked if a water-ballast-bag is placed into the harness!

Tandem flights:

The Tanto Race is because of it's special shape not suitable for tandem flights. Neither as pilot's nor as passenger's harness!

Life span, replacing time of construction units, repair

The harness Tanto Race was built for high loads and strong use. Accordingly, for the choice of the materials particularly high criteria were set. However the life span depends also on the treatment of the harness by the pilot, so we recommend to check the harness from time to time, if there are faulty or damaged parts, which should be replaced or repaired then.

Especially take care of defective seams, which should be immediately repaired by an authorized workshop.
Further you have the possibility to send us the harness for checking.

In order to prevent problems with the harness we recommend:

- avoid handling with fire and sharp edged articles near your harness.
- avoid unnecessarily long sun effect, because ultraviolet radiation destroys the molecular structure of the material
- avoid the contact with seawater or acid liquids.

Maintenance and control:

The harness Tanto Race is more or less maintenance-free. But regular control in short periods gives you the guarantee of an unrestricted function of your belt system. Take particularly care that the buckles stay free of dirt.

Dealers:

AVA Sport Schweiz:

Flugsau GmbH, Gruobi 1, 6388 Grafenort, www.avasportcentral.ch

AVA Sport Frankreich:

Parapente Passion - 14 Rue Basse - 04500 Riez www.avasport.fr